

HUSKY 510



Gebrauchsanleitung

Komfort-Schiebe-Befestigung
mit DuoLift Zentralverriegelung

Instructions for use

Comfort sliding fitting
with central locking system

Instructions d'utilisation

Montage glissé facile
avec verrouillage centralisé

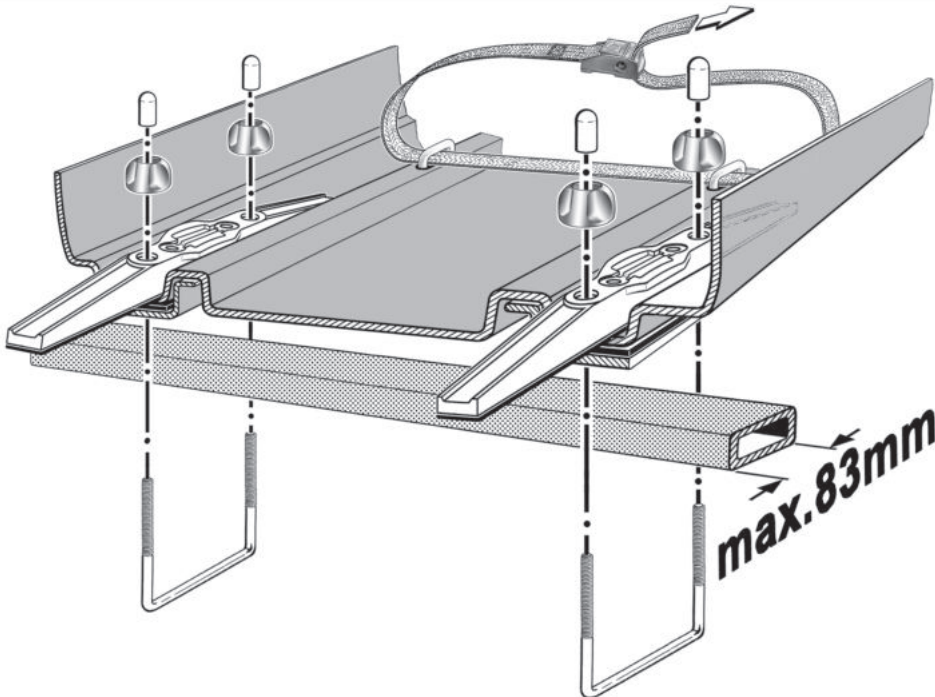
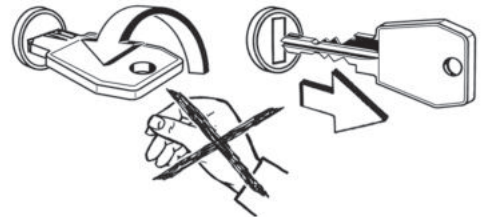
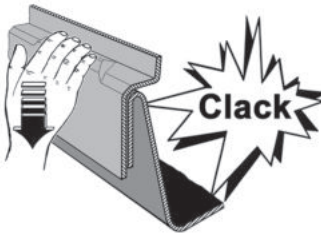
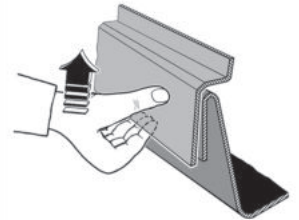
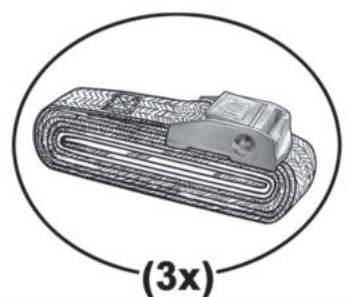
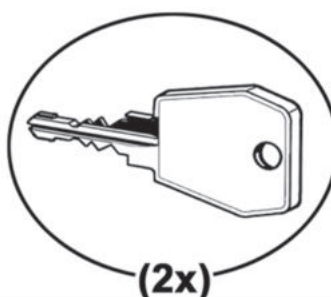
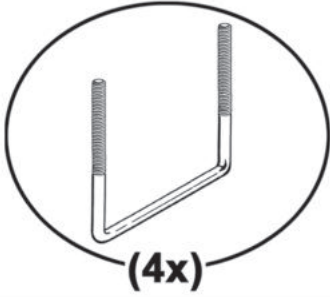

Art.-Nr. 0 52003 10
0 52005 10

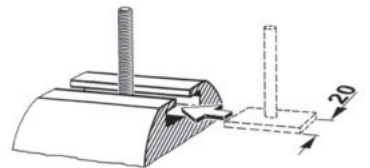

Art.-Nr. 0 52004 10

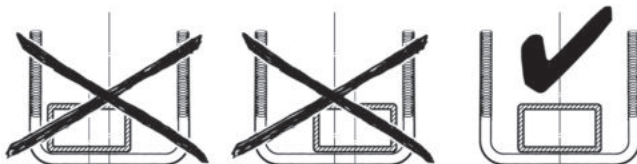
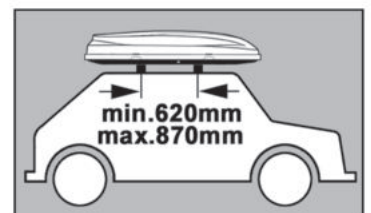
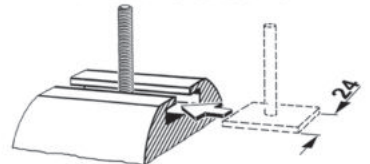

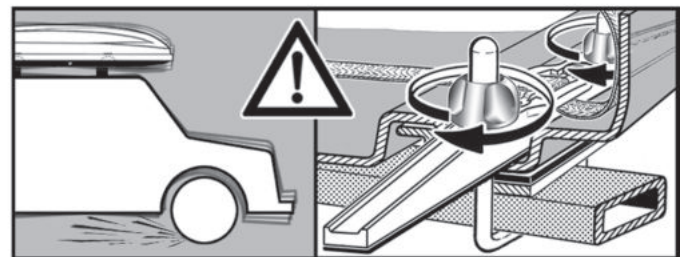
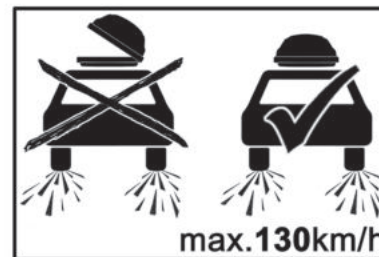
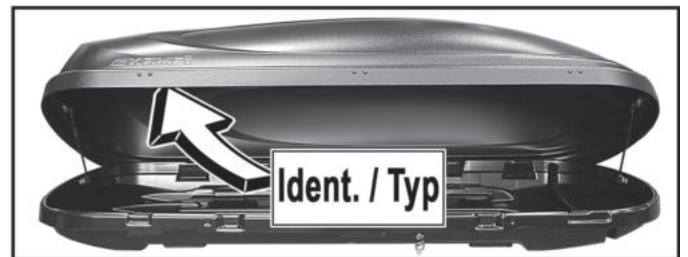
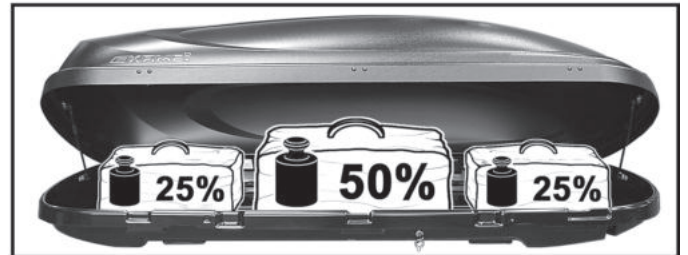
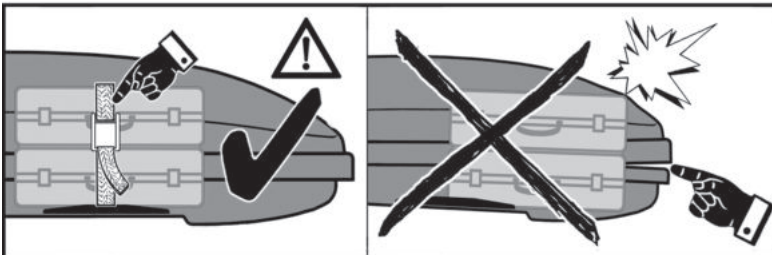
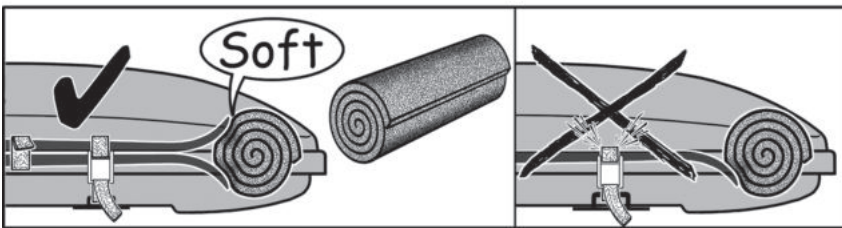
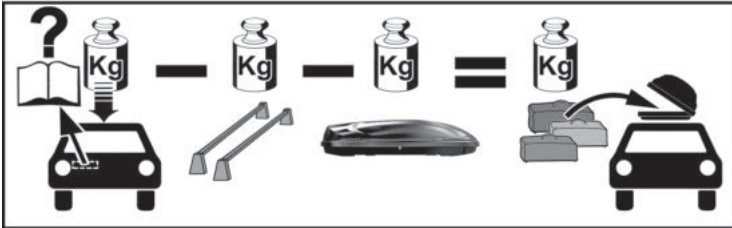
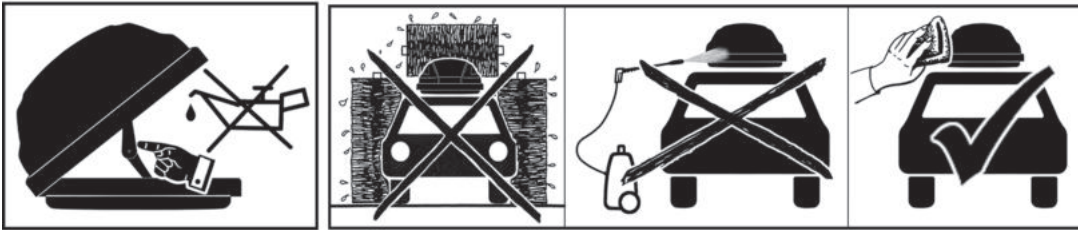
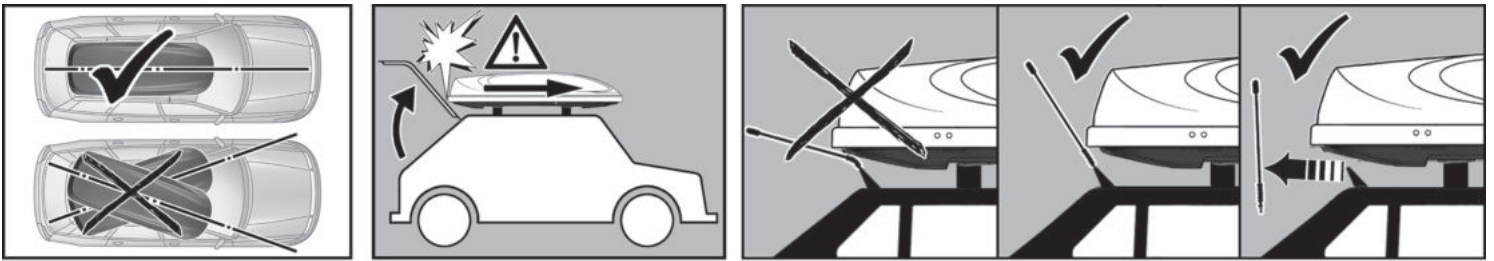

Dachcontainer Typ 81200

| Haupt-Verkaufsbezeichnung Auch andere Verkaufsbezeichnungen sind genehmigt | Maße | | | Volumen Schüttgut Liter | Gewichte | | |
|---|-------------|--------------|------------|-------------------------------|--------------------|-------------------------------|------------------------------|
| | Länge cm | Breite cm | Höhe cm | | Eigengewicht kg | zulässige Tragfähigkeit kg | Maximalgewicht beladen kg |
| Husky 510 schwarz - matt | 200 | 90 | 44 | 510 | 18 | 75 | 93 |
| Husky 510 schwarz - hochglanz | 200 | 90 | 44 | 510 | 19 | 75 | 94 |

Hersteller: KAMEI